

Interactive Science Laboratories

for secondary schools

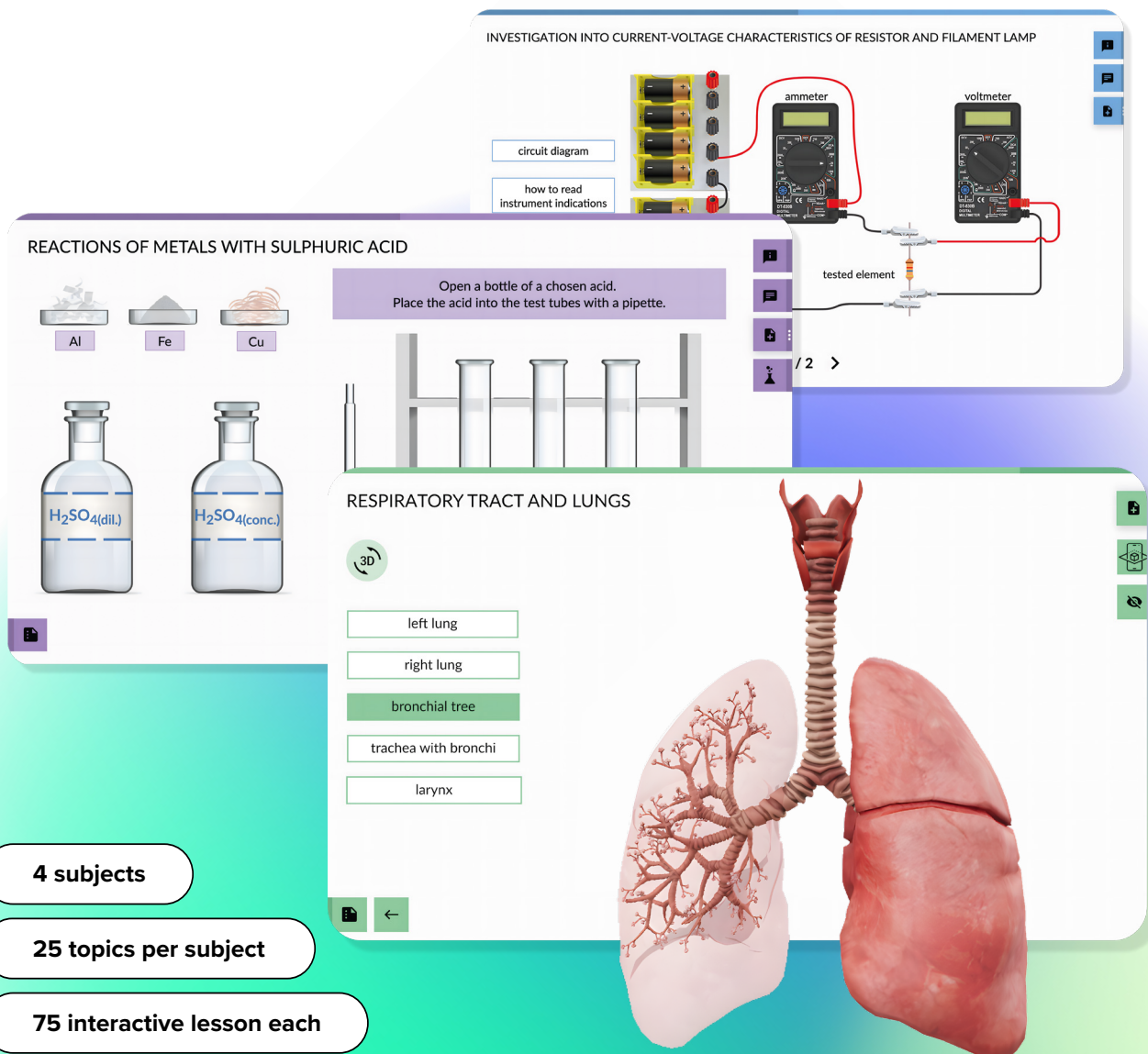

INVESTIGATION INTO CURRENT-VOLTAGE CHARACTERISTICS OF RESISTOR AND FILAMENT LAMP

circuit diagram
how to read instrument indications

ammeter
voltmeter
tested element

REACTIONS OF METALS WITH SULPHURIC ACID

Al Fe Cu

Open a bottle of a chosen acid.
Place the acid into the test tubes with a pipette.

H_2SO_4 (dil.) H_2SO_4 (conc.)

RESPIRATORY TRACT AND LUNGS

3D

left lung
right lung
bronchial tree
trachea with bronchi
larynx

4 subjects

25 topics per subject

75 interactive lesson each

Dozens of printable worksheets

What is ISL?

Interactive Science Laboratories (ISL) is a comprehensive set of interactive eContent designed for teaching biology, chemistry, physics, and geography at the secondary education level. These programs provide excellent materials for teachers conducting lessons in remote, hybrid, and in-person settings.

ISL supports students in developing social and digital competencies, as well as in enhancing their critical thinking skills. The programs focus on the scientific method, teaching students to ask questions, formulate hypotheses, conduct experiments, collect and analyze data, and draw conclusions. ISL adopts a modern approach to learning, utilizing strategies such as the flipped classroom model and blended learning.

Why choose ISL?

The engaging materials provided by ISL add unparalleled value to lessons, ensuring active participation from all students. Whether it's inspiring simulations, conducting experiments, or even dissecting frogs, these activities can be easily integrated into any virtual or traditional classroom setting. Teachers can effortlessly share their screens and conduct interactive lessons, significantly boosting students' interest in education. We recommend assigning students tasks and assessments through the multifunctional mCourser LMS platform to complete the learning process effectively and successfully.



Modern curricula for secondary schools

ISL curricula address the needs of modern learners. These materials capture students' attention, foster their digital and social competencies, and greatly ease the workload of teachers.



Truly interactive resources

Unlike static illustrations and flat PDFs, ISL programs are brimming with a diverse range of multimedia elements, including videos, animations, recordings, simulations, and 3D models, complemented by engaging interactive exercises.



Work on any device

ISL is developed in a contemporary HTML5 environment, ensuring the programs don't require installation and are compatible with wide are of devices, including computers, laptops, tablets, interactive whiteboards, and displays.



Verified educational materials

ISL materials were developed in collaboration with experienced educators. Each lesson has undergone thorough verification in terms of content and practicality, ensuring the highest quality of education.

How to work with ISL?

The ISL programs are invaluable to teachers in covering even the most difficult topics in the core curriculum.

Teachers can introduce, present, and discuss subjects in depth using an interactive whiteboard or other multimedia players. Students engage with the material by working on printable worksheets, completing assignments, and participating in various assessment models on the mCourser LMS platform. After these activities, teachers receive automatic, detailed reports on the performance of the entire class and individual students, provided by Big Data analytics.

What makes ISL effective?

- ISL is grounded in working with scientific methods.
- Encourages students' independent thinking and promotes engagement through group work.
- Introduces learning by drawing conclusions from experience.
- Helps students become acquainted with laboratory equipment.
- Merges theoretical knowledge with practical experiments and simulations.

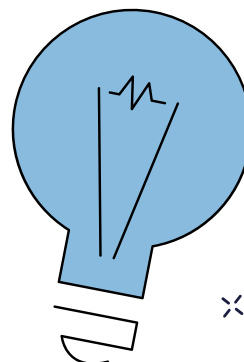
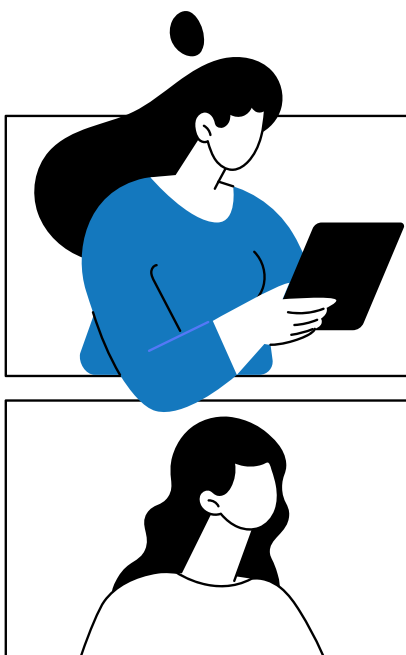

What is included in ISL?

Each program package, covering biology, chemistry, physics, and geography, contains:

- Resources that are aligned with the STEM curriculum.
- Standard and extended content for each subject.
- Range of engaging materials such as virtual and augmented reality elements, 3D and 2D simulations, videos, animations, pictures, and audio recordings.

BIOLOGY

The essential database of interactive materials for studying biology.

- Photographs from laboratory experiments featuring microscopic preparations, illustrating samples from both plant and animal tissues.
- A collection of illustrations, photographs, and videos documenting observations and experiments with plants and animals, as well as activities performed in biology laboratories.
- An interactive human anatomy atlas featuring detailed presentations of individual structures of the human body.
- 3D models showcasing selected human organs.
- A feature enabling the modeling of experimental procedures, including the selection of appropriate reagents, equipment, and materials for examination.
- Tools designed to help develop skills in planning and conducting biological studies.

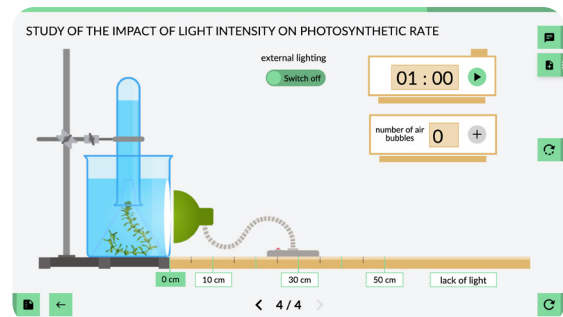
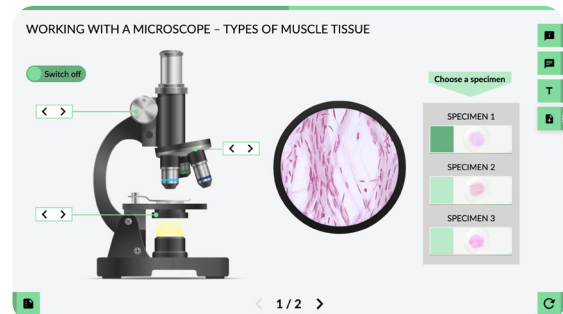

List of topics covered in ISL Biology

1. Starch detection in selected food products
2. Protein coagulation
3. Protein denaturation
4. Detection of peptide bonds
5. Characteristic reactions of proteins
6. Eucaryotic and procaryotic cells – similarities and differences
7. External and internal factors affecting the intensity of photosynthesis
8. Working on the microscope – plant tissue
9. Plant tissue atlas
10. Monocotyledon and dicotyledon plants
11. Water transport in a plant
12. Seed germination ability
13. Effect of deficiency of selected elements on plant growth and development
14. Phytohormones and plant movements
15. Identification of arthropods
16. Internal structure of an amphibian
17. Working on the microscope – muscle tissue
18. Gastrointestinal system
19. Lung structure and function
20. Heart structure and function
21. Nervous system
22. Eye and ear
23. Skeletal system structure
24. Structure and types of bones
25. Joints – mobile connections between bones

GEOGRAPHY

Discover the world through interactive geographic experiences.

- Interactive maps, diagrams, and charts covering socio-economic global geography topics.
- Animated simulations of physical geographical phenomena and processes.
- 3D illustrations of celestial bodies in the Solar System and beyond.
- Tasks involving data analysis from tables, graphs, and maps to draw conclusions.

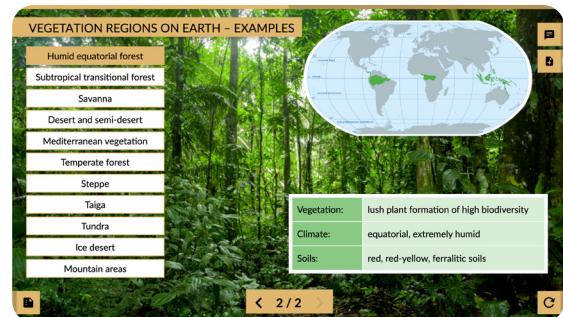
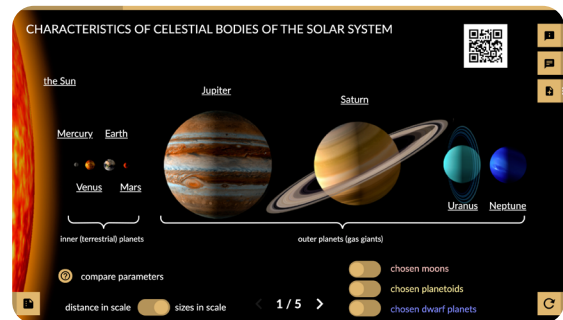

List of topics covered in ISL Geography

1. Maps and their use
2. Rotation of the Earth and time zones
3. Celestial bodies of the Solar System
4. Calculation of geographical coordinates based on astronomical observations
5. The Moon – a satellite of the Earth
6. Weather forecast based on synoptic maps and satellite images
7. Climates of the Earth
8. Types of lakes
9. Plutonism and volcanism
10. Geological profile analysis
11. Weathering
12. Earth sculpting factors
13. Rocks and minerals
14. Soil and soil types
15. Vertical vegetation diversity
16. Vegetation zones on the Earth
17. Analysis of socio-economic development indicators
18. Demography
19. Energy sources
20. The role of tourism in the world economy
21. Diseases of the world
22. Water pollution in the Baltic Sea

PHYSICS

Physics in motion - an interactive learning adventure.

- Simulated experiments with real-world conditions, including measurements.
- Processing measurement results, including uncertainty analysis.
- Simulations of physical phenomena based on real-world measurements.
- Video-guided simulations of physics experiments.
- Online student observation sheets for recording and presenting measurements, from observations to conclusions.

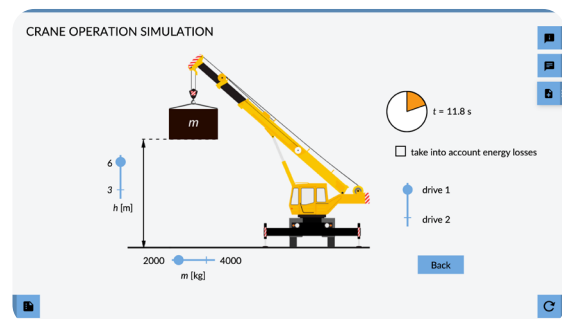
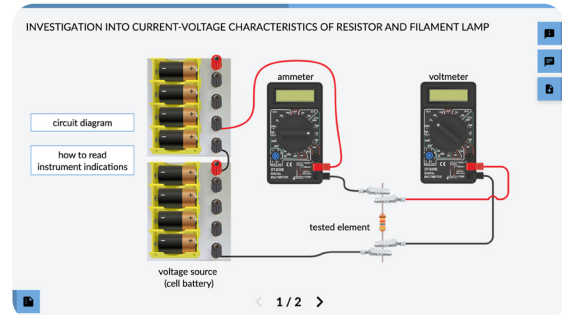

List of topics covered in ISL Physics

1. Second law of motion
2. Circular motion
3. Determination of the coefficient of friction
4. Buoyancy force
5. Torque
6. Characteristics of celestial bodies of the Solar System
7. Properties of a mathematical pendulum. Determination of standard acceleration due to gravity
8. Work, power, energy
9. Determination of the specific heat of solids
10. Temperature changes during phase transitions
11. Heat engines
12. Capacitors
13. Kirchhoff's first law
14. What the electrical resistance of a conductor depends on
15. A study of the current-voltage characteristics of a resistor and an incandescent lamp
16. Determination of SEM and internal resistance
17. Diodes in an electrical circuit
18. Domestic electricity networks
19. Motion of an electric charge in a magnetic field
20. Magnetic field generated by moving electric charges
21. Transformers
22. Determination of the refractive index
23. Diffraction grating
24. Polarisation of light
25. Decay of a radioactive isotope

CHEMISTRY

Chemistry mastery through essential interactive resources.

- Designing and describing chemical experiments, including experiment schematics, reagent selection, laboratory glassware.
- Interactive simulations with animations and graphics illustrating chemical experiments.
- Short videos of real-world chemical experiments with informative commentary.
- Guidance on how to perform experiments.
- Developing observation and conclusion-drawing skills through hands-on chemical experiments.
- Exploring 3D models of chemical structures.

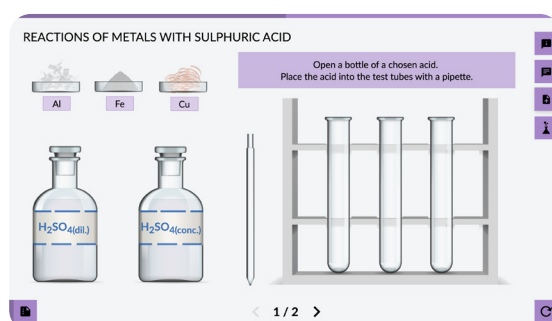
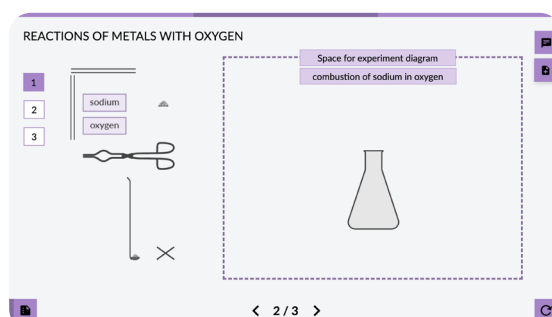

List of topics covered in ISL Chemistry

1. Natural radioactivity
2. Preparation of solutions with a specific percent concentration
3. Preparation of solutions with a specific molar concentration
4. Reaction and pH of solutions
5. Alkacymetric titration
6. Reactions of precipitate formation
7. Ammonia properties
8. Distinguishing calcareous rocks from other rocks
9. Catalytic reactions
10. Hydrogen production
11. Oxygen production
12. Metal reactions with oxygen
13. Metal reactions with hydrochloric acid
14. Metal reactions with sulphuric(VI) acid and nitric(V) acid
15. Chemical activity of metals
16. Oxidation numbers of manganese
17. Galvanic cells
18. Water electrolysis
19. Mono- and polyhydroxy alcohols
20. Tollens' test
21. Trommer's test
22. Soap receiving reaction
23. Detection of proteins
24. Sucrose properties
25. Fibres

Leverage our Global Expertise in Interactive Educational Publishing

Learnetic Educational ePublishing Suite is built upon incremental expertise from over **350 projects** across **50 countries** worldwide.



Find out more at
www.learnetic.com/is/



Learnetic
www.learnetic.com